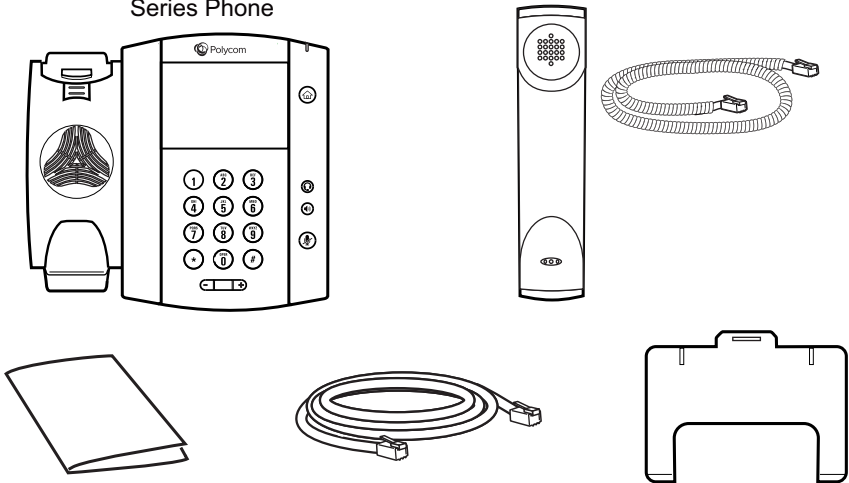

**VVX 500/501****VVX 600/601**

**Note:** For more information on your Polycom<sup>®</sup> VVX<sup>®</sup> 500 series and VVX 600 series business media phones, see user documentation, including Quick User Guides and User Guides, on your phone's Support page on Polycom Voice Support: <http://support.polycom.com/voice>.

## Package Contents

VVX 500 or VVX 600  
Series Phone

## Optional Accessories

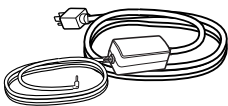

AC Power Cord and Adapter

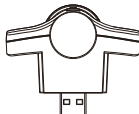

VVX Camera

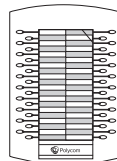
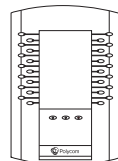
VVX Expansion Module  
(paper display)VVX Expansion Module  
(LCD color display)

For more information, contact your reseller.

## Features

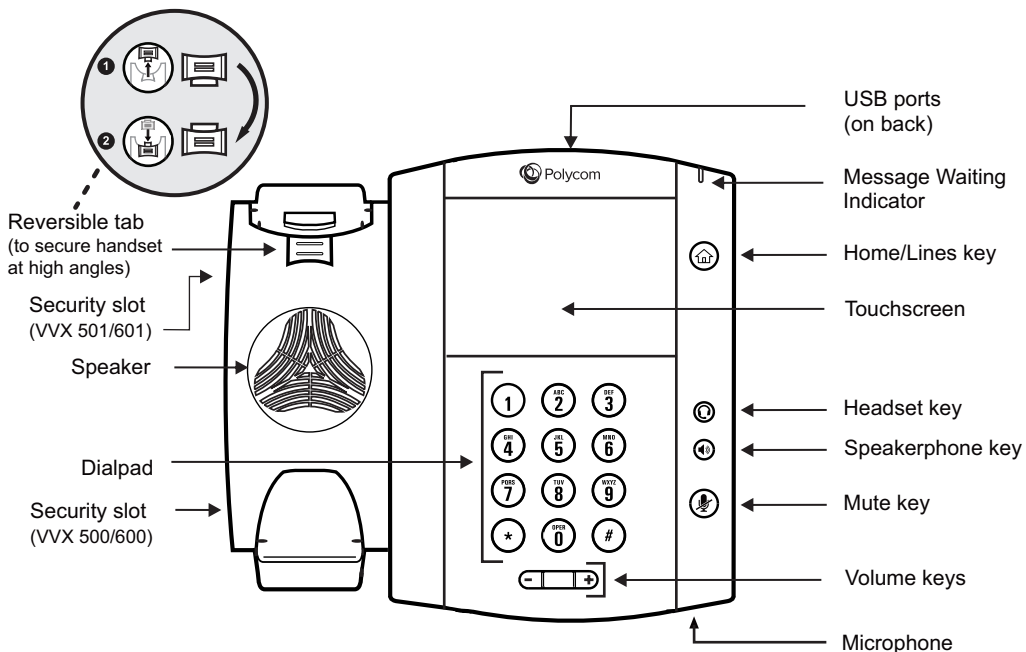

## Connect Cables

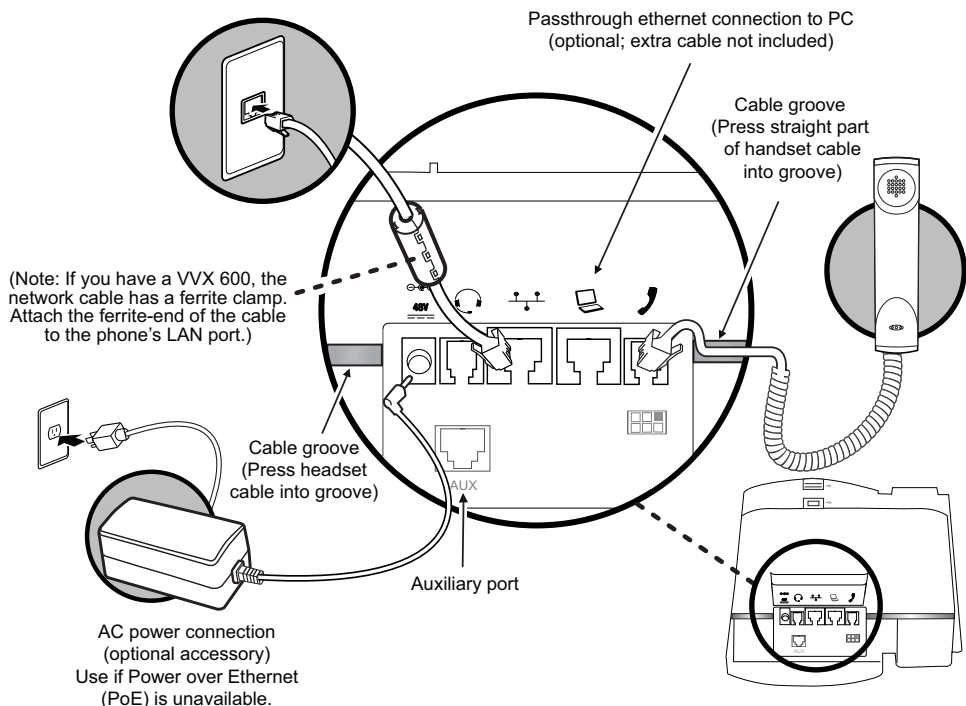

## Connect Stand\*

Fully insert the stand into one of the slots on the back of the phone. The slot you choose determines the angle of the phone. For high-angle use, secure the handset with the reversible tab (see **Features**).

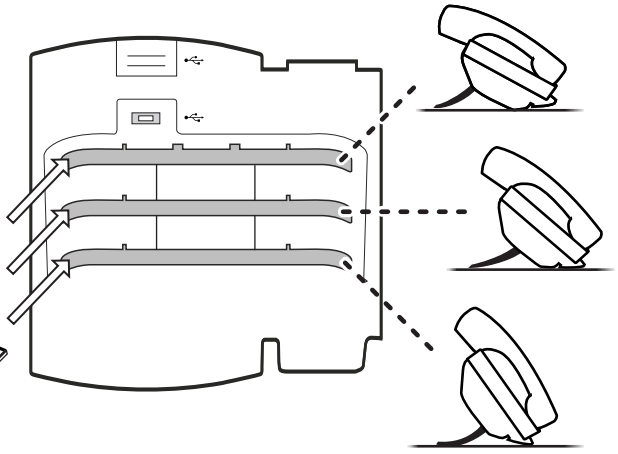
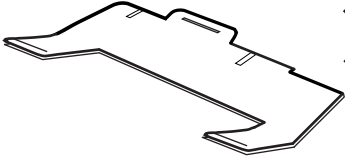

\*For wallmount installation, an optional accessory is available. For more information, contact your reseller.

## Connect Optional Headset

Your phone supports wired and wireless headsets, including electronic hookswitch (EHS) headsets. VVX 600/601 phones also support Bluetooth headsets.

For connection directions, refer to your headset documentation. Standard headsets typically use the RJ-9 or USB port, while EHS headsets use the RJ-9 and serial port. The ports are on the back of your phone, as shown in the diagram.

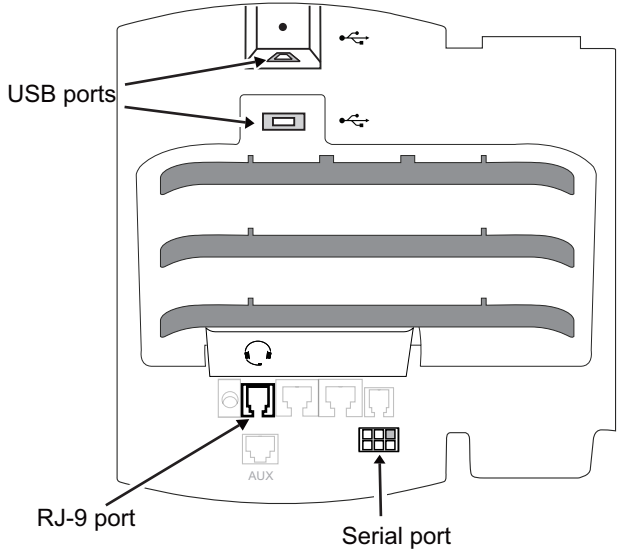

## Connect Optional USB Devices

You can attach a USB headset, or a USB flash drive (to record calls, use the Digital Picture Frame feature, or to change the background picture on your phone). To learn more, see your phone's User Guide.

